

# ***INTRODUCTION TO POWER SYSTEM PROTECTION***

*with self-test & tutorial question*

**NORANIZAH SOLIHIN**



# ***INTRODUCTION TO POWER SYSTEM PROTECTION***

*with self-test & tutorial question*

**Writer**

**Noranizah Bt Solihin**

**Published in 2021**

**All rights reserved. No part of this publication may be reproduced, distributed, or transmitted in any form or by any means, including photocopying, recording, or other electronic or mechanic methods, without the prior written permission of the writer, except in the case of brief quotations embodied in reviews and certain other non-commercial uses.**

**Perpustakaan Negara Malaysia**

**Cataloguing-in-Publication Data**

**Noranizah Solihin**

**INTRODUCTION TO POWER SYSTEM PROTECTION :**

**with self-test and tutorial question / NORANIZAH SOLIHIN**

**Mode of access: Internet eISBN 978-967-2762-02-7**

- 1. Electric power systems.**
- 2. Electric power systems--Protection.**
- 3. Government publications--Malaysia.**
- 4. Electronic books.**

**I. Title.**

**621.31**

## **EDITORIAL BOARD**

**Managing Editor**

**Ts Dr. Maria binti Mohammad  
Rosheela binti Muhammad Thangaveloo**

**Nisrina binti Abd Ghafar**

**Azrina binti Mohmad Sabiri**

**Zuraida bt Yaacob**

**Raihan binti Ghazali**

**Editor**

**Mohd Asmadi Bin Idris**

**Designer**

**Noranizah Bt Solihin**

**Proofreading & Language Editing:**

**Nor Fazila binti Shamsuddin**

**Maisarah binti Abdul Latif**

**Rosheela binti Muhammad Thangaveloo**





# **ACKNOWLEDGEMENT**

**I would like to acknowledge and give my warmest thanks to all my friends who made this book possible. The guidance and advice carried me through all the stages of writing this book.**

**I would also like to give special thanks to my husband and my children as whole for their continuous support and understanding when writing my book. Your prayer for me was that sustained me this far.**

**Finally, I would like to thank ALLAH, for letting me through all difficulties. I have experienced your guidance day by day. Thank you ALLAH.**



# **PREFACE**

**In an electrical power system, protection system is essential for generation, transmission, and distribution. The objective of power system protection is to isolate a faulty section of an electrical power system from the rest of the live system so that the rest of the system can function normally without suffering severe damage from fault current.**

**This book introduce the basic fundamental of protection system included the basic component used in power system protection. It also discusses the different types of faults in power systems and the significance of protective zones in power systems.**

**This book gives education in the theory of power system protection. It also includes a self-test and tutorial questions and is appropriate for students and lecturers in the electrical field.**



# TABLE OF CONTENT

<b><i>TITLE</i></b>	<b><i>PAGE</i></b>
<b>ACKNOWLEDGEMENT</b>	
<b>PREFACE</b>	
<b>01 : INTRODUCTION TO PROTECTION SYSTEM</b>	
<b>INTRODUCTION</b>	<b>1</b>
<b>DEFINITION</b>	<b>3</b>
<b>REASON</b>	<b>4</b>
<b>OBJECTIVE OF POWER SYSTEM PROTECTION</b>	<b>5</b>
<b>SELF -TEST QUESTION</b>	<b>8</b>
<b>02 : BASIC REQUIREMENT FOR EVALUATING POWER SYSTEM PROTECTION</b>	
<b>RELIABILITY</b>	<b>10</b>
<b>SPEED</b>	<b>11</b>
<b>SELECTIVITY</b>	<b>13</b>
<b>SIMPLICITY AND ECONOMY</b>	<b>15</b>
<b>SENSITIVITY</b>	<b>16</b>
<b>SELF -TEST QUESTION</b>	<b>17</b>





# TABLE OF CONTENT

<b><i>TITLE</i></b>	<b><i>PAGE</i></b>
<b>O3 : TYPES OF FAULT IN POWER SYSTEM</b>	
<b>FAULTS IN POWER SYSTEM</b>	<b>18</b>
<b>SYMMETRICAL FAULT</b>	<b>21</b>
<b>UNSYMMETRICAL FAULTS</b>	<b>23</b>
<b>SELF -TEST QUESTION</b>	<b>28</b>
<b>O4 : BASIC COMPONENT OF PROTECTION</b>	
<b>CURRENT AND VOLTAGE TRANSFORMERS</b>	<b>31</b>
<b>CIRCUIT BREAKER</b>	<b>40</b>
<b>PROTECTIVE RELAY</b>	<b>51</b>
<b>FUSES</b>	<b>57</b>
<b>BATTERIES</b>	<b>61</b>
<b>SELF -TEST QUESTION</b>	<b>63</b>



# TABLE OF CONTENT

<b><i>TITLE</i></b>	<b><i>PAGE</i></b>
<b>O5 : PROTECTIVE ZONES</b>	
<b>WHAT IS PROTECTIVE ZONES?</b>	<b>64</b>
<b>OVERLAPPING ZONES</b>	<b>66</b>
<b>PRIMARY AND BACK-UP PROTECTION</b>	<b>68</b>
<b>SELF -TEST QUESTION</b>	<b>70</b>
<b>TUTORIAL QUESTION</b>	<b>71</b>
<b>REFERENCES</b>	<b>73</b>

01

# ***INTRODUCTION TO PROTECTION SYSTEM***





# Introduction

Electric power system is composed of the components or elements such as generators, transformers, transmission lines and distribution lines, bus bars and others. Short circuits and other abnormal conditions in the power system are common and can cause damage to power system equipment.

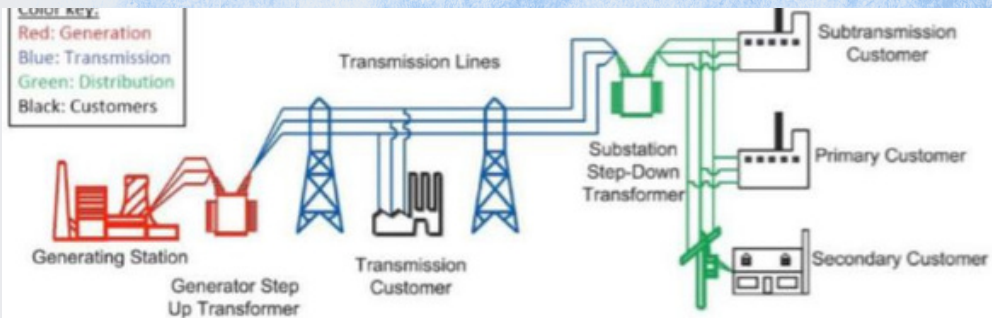

Figure 1: Basic Electric Power System  
(<http://electricalarticle.com/>)



The main purpose of any electrical supply system is to meet all of the customers' energy demands. The transmission system transports large amounts of energy to major load centres, while distribution systems deliver electricity to the farthest client at the lowest voltage level possible.

Therefore, the protection components, such as relay, circuit breaker and many other components installed in power system protection to protect power system equipment.



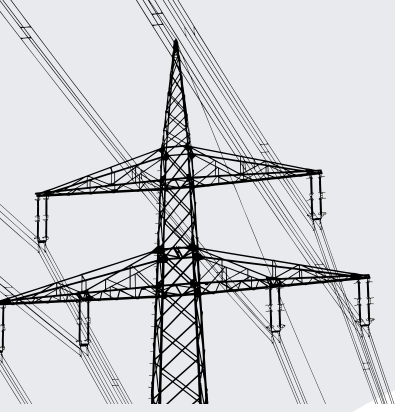

# Definition

Power system protection is a branch of electrical power engineering that deals with the protection of electrical power systems from faults through the isolation of faulted parts from the rest of the electrical network.

The term "protection" refers to the process of **caring for or protecting an electrical installation from dangers/hazards generated by an electric current**, such as overcurrent, earth leakage current, short circuit, lightning, and so on.



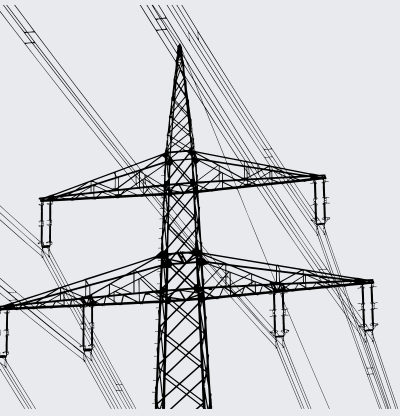

# Reason

The main purpose of power system protection is to protect all elements / components of the power system that includes generators, transformers, transmission lines and distribution ,bus bars (busbars) and others from the risk of damage such as short circuits and other abnormal conditions regularly occurs in the power system.

- To Protect human life
- To protect buildings and property from fire
- To protect electrical equipment from damage and fire.





# Objective of Power System Protection

A protection scheme's goal is to keep the power system stable by isolating only the components that are faulty, while leaving as much of the network as possible operational.

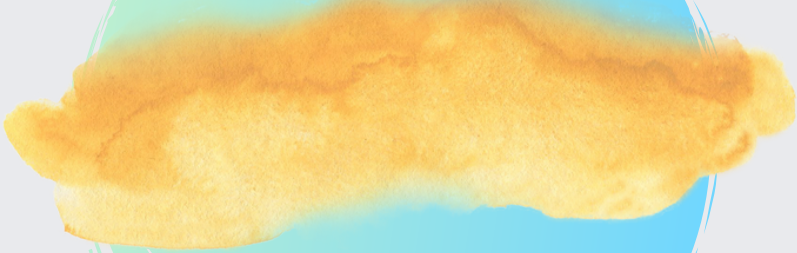

When an abnormal or fault condition arises, the protection system must be able to identify it quickly so that the affected part can be isolated, allowing the rest of the power system to continue operating and limiting the risk of damage to other equipment.





**Equipment disconnections must be kept to a minimum in order to isolate the fault from the system.**

**The protection must be sensitive enough to function when a fault occurs under minor fault conditions, but stable enough not to operate when its connected equipment is carrying the maximum rated current, which could be a short-term value.**

**It must also be fast enough to eliminate the defect from the system , minimising damage to system components while remaining reliable in operation.**





# 5 Main Objective

**Detect abnormal condition**

**Selectivity remove fault area**

**Keep power system stable**

**Rapidly remove fault**

**Ensure continuous supply**





# Self-Test Question

1. The term "protection" refers to \_\_\_\_\_ from dangers/hazards generated by an electric current, such as overcurrent, earth leakage current, short circuit, lightning, and so on.

2. The \_\_\_\_\_ of a protection scheme is to keep the power system stable by isolating only the components that are under fault.

3. Short circuits and other abnormal conditions often occur in the power system and can cause \_\_\_\_\_ to the power system equipment.

4. The protection must be sensitive enough to operate when \_\_\_\_\_ under minimal conditions.



02

**BASIC  
REQUIREMENT  
FOR EVALUATING  
POWER SYSTEM  
PROTECTION**



Any power system's protection arrangements must take into account the following fundamental principles.:



**Reliability**



**Speed**



**Selectivity**



**Simplicity and Economy**



**Sensitivity**

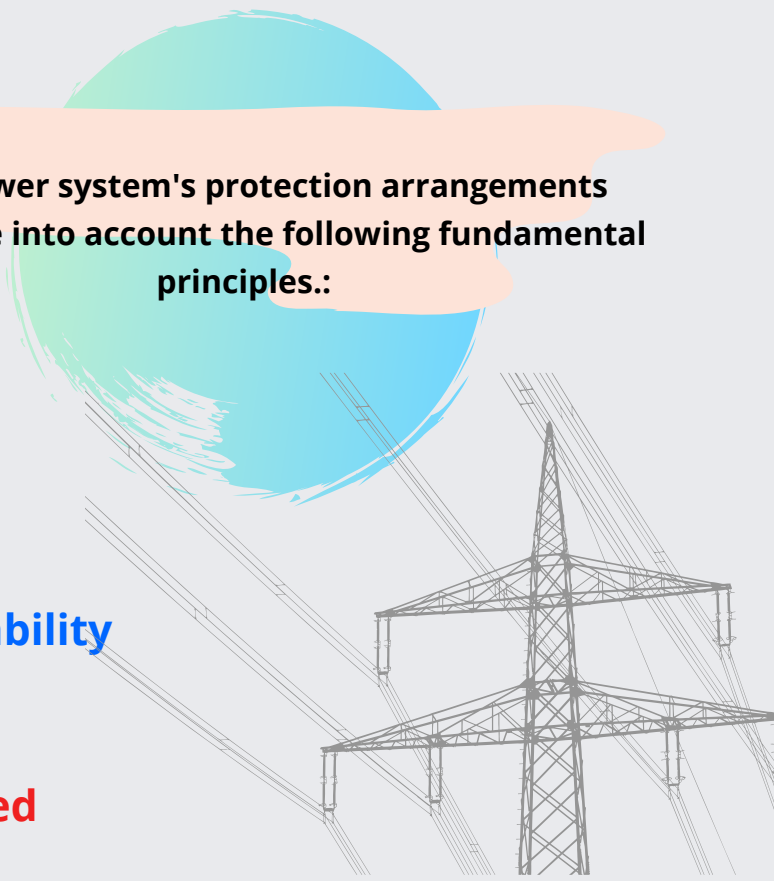



# Reliability

**The ability of the protection to operate correctly**

**The protection system employed must increase the system's dependability. The protection system should be reliable in the sense that it should always be ready to function properly at all times. They should also work when there are any abnormal conditions, such as a fault.**

**It has two elements -**

- Dependability is the assurance of a correct operation in the event of a failure.**
- Security refers to the capacity to avoid incorrect operation in the event of a failure.**





# Speed

**Minimum operating time to clear a fault in order to avoid damage to equipment.**

**As soon as possible, the faulty sections must be isolated or disconnected from the system. The speed of operation of the protection system should be increased.**



**This condition assures that the system suffers the least amount of damage as a result of the fault, that power system stability is maintained, that customers' power outage time is minimised, and that the development of other types of faults triggered by the first failure on the system is minimised.**

**The speed of operation for transient faults must be kept to a desirable level, as too fast operation may result in undesirable operation.**







# Selectivity

**Maintaining continuity of supply by disconnecting the minimum section of the network necessary to isolate the fault.**

**The protection system must be capable of appropriately identifying the system component that is causing the problem.**

**It should also be able to isolate or disconnect that element of the system from the rest of the system without causing problems elsewhere.**



This means that the protection system should be able to distinguish between the disturbing part and the rest of the circuit.

The ability of well-designed protection to recognise the point at which the fault occurs and cause the circuit breakers nearest to the fault to operate is known as **selectivity**.

Selectivity is usually achieved by partitioning the entire system into various **protective zones**.





# Simplicity and Economy

The protective system should be as simple as possible so that it can be easily maintained and the cost of the system should be well within limits.  
(maintenance costs low and reasonable)

The simplicity of construction combined with the correctness of the design of the protection system results in a lower number of relays, circuits, and contacts.

In addition to the technical aspects and technical requirements of the protection system, the system must be able to justify itself economically in real life.





# Sensitivity

**It can detect fault at an early stage.**

**When a fault, abnormal condition, or short circuit current is detected, the protection system must be sensitive enough to detect it and act reliably.**

**Sensitivity is the smallest value of the actuating quantity that causes the protection system to operate.. The higher the system's sensitivity, the greater its complexity and cost.**





# Self-Test Question

1. \_\_\_\_\_ is the ability of the protection to operate correctly
2. Reliability has two elements which is \_\_\_\_\_ and \_\_\_\_\_.
3. The protective system should be as simple as possible so that it can be \_\_\_\_\_ and the \_\_\_\_\_ of the system should be well within limits.
4. Protection system should also be able to \_\_\_\_\_ that part of the system from the rest of the system without causing problems elsewhere.



03

# **TYPES OF FAULT IN POWER SYSTEM**



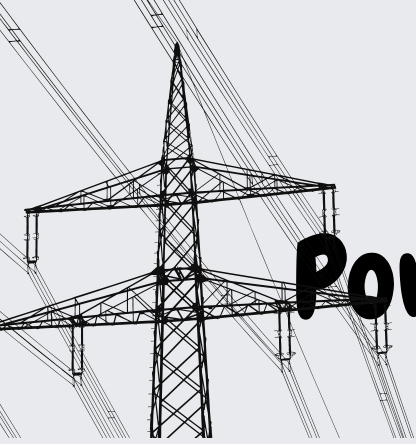

# Faults in Power System

**A fault in a circuit is any failure that interferes with the normal operation of the system.**

**A fault occurs when two or more conductors that normally operate with a potential difference come into contact with each other.**

**These faults can occur as a result of a sudden failure of a piece of equipment, accidental damage or short circuit to overhead lines, or insulation failure as a result of lightning surges.**



The majority of faults on high-voltage transmission lines are caused by lightning strikes, which generate a very high transient voltage that far exceeds the rated voltage of the line.

This voltage usually causes a flashover between the phases and/or the ground, which results in an arc. Due to the low impedance of this new path, an excessive current may flow.

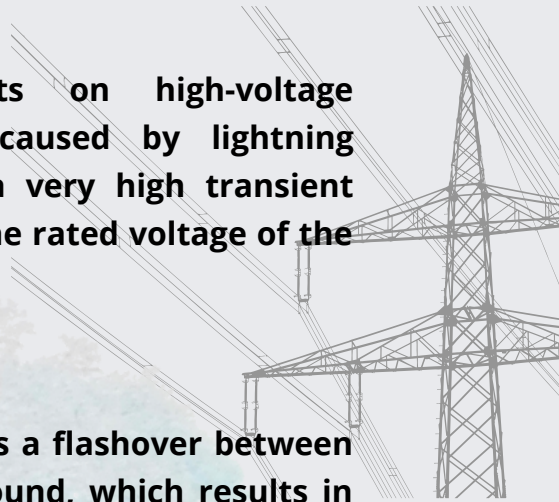



The faults in a three phase (3-phase) system can be divided into two main categories:

**Symmetrical faults**

**Unsymmetrical faults**

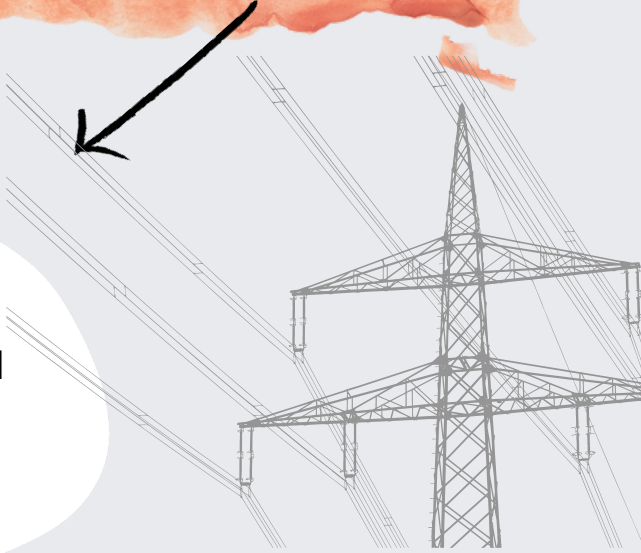



# Symmetrical Fault

The fault in electrical transmission line which give rise to symmetrical fault current is called symmetrical fault.

The most common example of symmetrical fault is when all the three conductors of a **3-phase line are brought together simultaneously** into a short-circuit condition.e.g; **L-L-L-G fault and L-L-L .**

In practise, symmetrical faults are uncommon because the vast majority of faults are unsymmetrical. However, symmetrical faults are the most severe and place a greater burden on the circuit breaker.



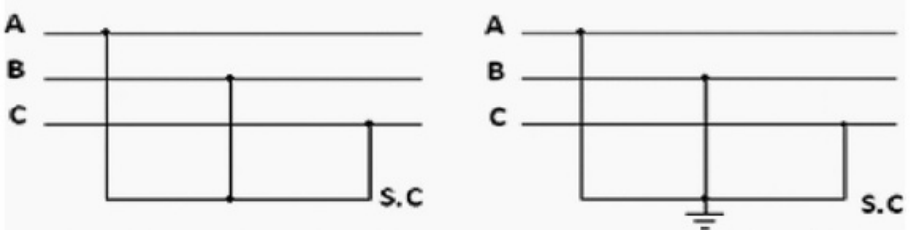

**Figure 2 :L-L-L and L-L-L-G Fault**  
(<https://electrical-engineering-portal.com/>)





# Unsymmetrical Faults

The fault in transmission line which give rise to unsymmetrical fault current is called unsymmetrical fault.

Unsymmetrical faults involve one line to ground or two lines to ground. fault.e.g; L-L , L-L-G , L-G fault

The majority of power system faults are unsymmetrical in nature, with the most common type being a short-circuit from one line to ground.



**There are three types of symmetrical faults:**

 **Single line to ground fault (L-G)**

 **Double line to ground fault (2L-G)**

 **Line to line Fault (L-L)**





# Single line to ground fault (L-G)

Short circuit between a conductor and earth known as a phase of damage on earth. It may be due to failure of insulation between the phase conductor and earth or phase conductor breaks and falls to the ground.

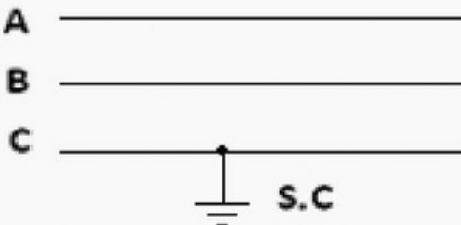

Figure 3 :L-G Fault  
(<https://electrical-engineering-portal.com/>)





# Double line to ground fault (2L-G)

Short circuit between any two phase to earth ground and called the fault to two lines or two-phase to ground.

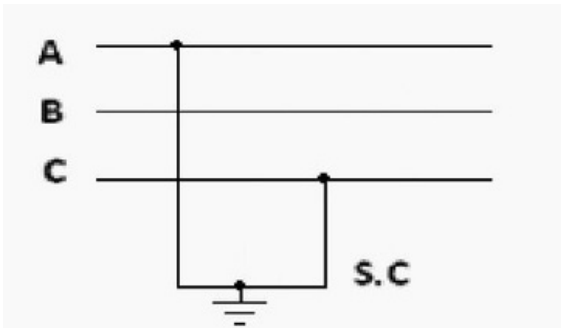

Figure 4 :L-L-G Fault  
(<https://electrical-engineering-portal.com/>)





# Line to line Fault (L-L)

Short circuit between any two phase is called line to line fault or phase to phase.

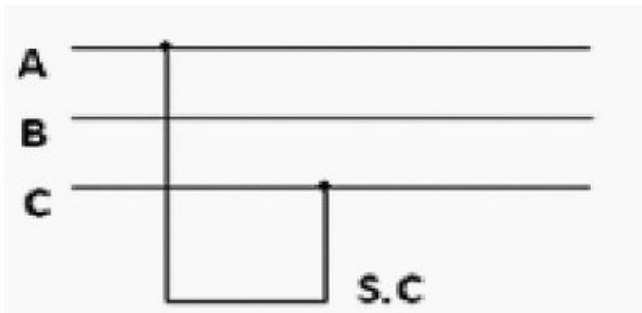

Figure 5 :L-L Fault  
(<https://electrical-engineering-portal.com/>)







# Self-Test Question

1. \_\_\_\_\_ in a circuit is any failure that interferes with the normal operation of the system.
2. The majority of faults on high-voltage transmission lines are caused \_\_\_\_\_ which generate a very high transient voltage that far exceeds the rated voltage of the line.
3. \_\_\_\_\_ is when all the three conductors of a 3-phase line are brought together simultaneously into a short-circuit condition
4. Unsymmetrical faults involve \_\_\_\_\_ or two lines to ground fault.



04

**BASIC  
COMPONENTS OF  
PROTECTION**

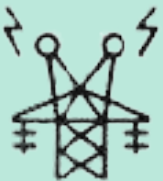

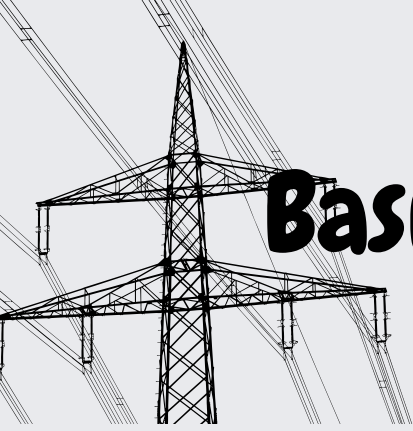

# 5 Basic Components

**Current and  
Voltage  
Transformers**

**Circuit  
Breaker**

**Protective  
Relay**

**Batteries**

**Fuses**



# Basic Schematic Circuit Protection Equipment

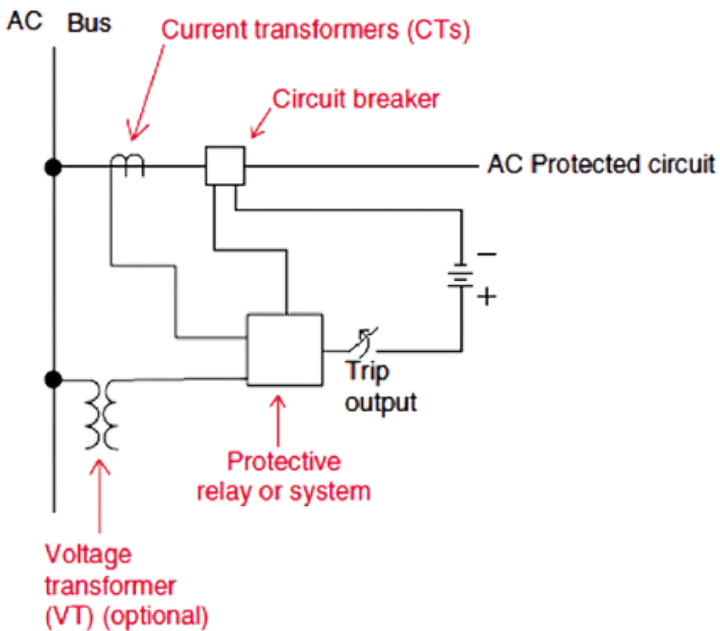

Figure 6: Basic Schematic Circuit Protection Equipment  
(<https://electrical-engineering-portal.com/>)



# Current and Voltage Transformers



Instrument transformers, either current or voltage, are used to protect, regulate, and measure equipment from the high voltages of a power system, as well as to supply the correct current and voltage values to the equipment - commonly 1A or 5A for current coils, and 120V for voltage coils.

Faults in a transformer's signal can cause relays to fail, and the behaviour of current and voltage transformers before, during, and after a fault is critical in electrical protection. In addition, when selecting the proper transformer, factors like as transient time and saturation must be taken into account.





# Voltage Transformers

In an electrical power system, a **voltage transformer (VT)** is used to step down the system voltage to a safe level that may be delivered to low-power meters and relays.

Low-voltage relays and metres are currently available for protection and metering.

The voltage transformer's primary winding is coupled across phase and ground. A voltage transformer's secondary winding has fewer turns than the primary winding. The main winding terminals of that transformer receive the system voltage, and the secondary terminals of the VT receive a commensurate secondary voltage.



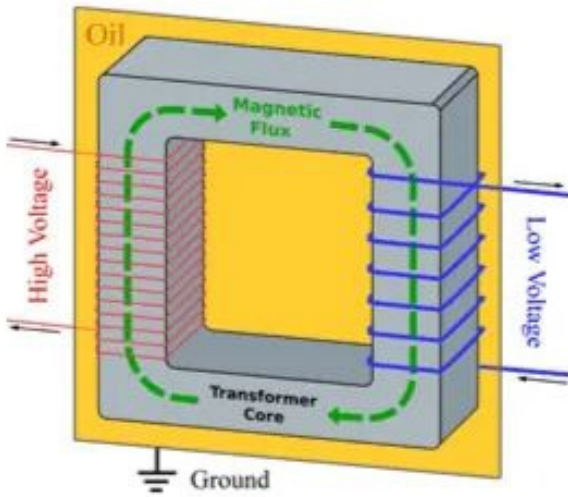

**Figure 7 :Basic Structure of Voltage Transformer**  
( <https://www.electrical4u.com/>)





**Figure 8 :High Voltage Transformer**  
(<https://www.electricityforum.com/>)







**Figure 9 :Low Voltage Transformer**  
(<https://www.rfparts.com/>)



# Current Transformers



The Current Transformer (C.T.) generates an alternating current proportional to the current measured in its main winding in its secondary winding. **Current transformers reduce high voltage currents to a safe level**, allowing a normal ammeter to be used to safely monitor the real electrical current flowing in an AC transmission line.

For normal operation, current transformers can reduce or "step-down" current levels from thousands of amperes to a standard output of a known ratio to either 5 Amps or 1 Amp.



**Current transformers are divided into two categories:**



**Measuring CTs - send signals to metres and instruments**



**Protection CTs - send signals to protective relays that allow them to operate correctly in both steady and transient states.**



Current transformers operate on the same principles as voltage transformers. A magnetic core has two or more windings. Current flowing in the primary winding drives current in the secondary winding, resulting in the formation of a magnetic field. The ratio of primary to secondary turns determines the current scaling .

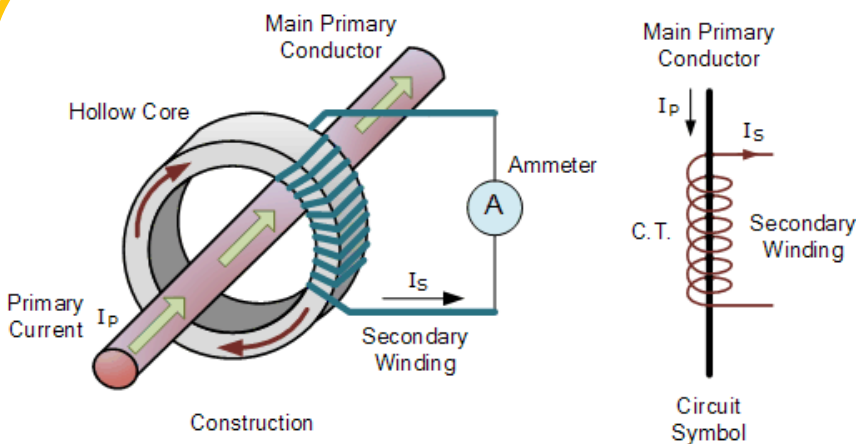

**Figure 10 :Basic Structure of Current Transformer**  
( <https://www.electrical4u.com/>)





**Figure 11 :Three Phase Current Transformer**  
(<http://www.meinstruments.in/>)



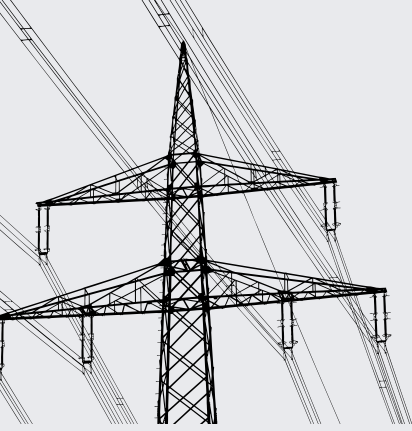

# Circuit Breaker

A circuit breaker is an electrical device that is used in a different circuit to protect against faults and breaks the circuit when fault such as a short circuit occurs.

It works both manually and automatically, and its design allows it to stop the circuit automatically.

**A circuit breaker main function is to interrupt the flow of current when a fault occurs.**



**A circuit breaker is a piece of equipment that :**

- Under normal condition, makes or breaks a circuit either manually or by remote control**
- When a circuit is tripped, it automatically breaks the circuit.**
- Under faulty conditions, make a circuit manually or with a remote control.**



As a result, a circuit breaker can operate between manual, remote, and automatic control modes and the latter control uses relays and operates at faulty condition.

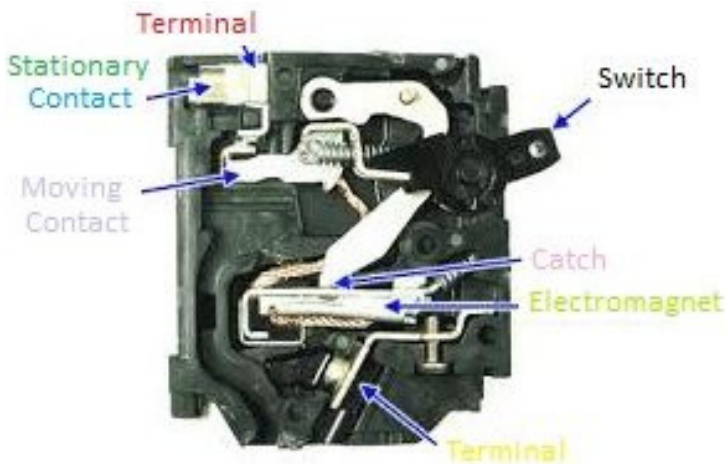

**Figure 12 :Basic Structure of Circuit Breaker**  
( [www.TheEngineeringKnowledge.com](http://www.TheEngineeringKnowledge.com))







# Operating Principle of Circuit Breaker

Circuit breaker will sense the fault occurs in the circuit. For a circuits with low voltage ratings, the breaker detects the fault itself and subsequently breaks the circuit.

For fault in high voltage circuits , protection relays are used to detect a fault and send a signal to the breaker, which then breaks the circuit.

Circuit breaker consist of moving contact and fixed contact called as electrodes.

It was made from high quality material with low resistance.



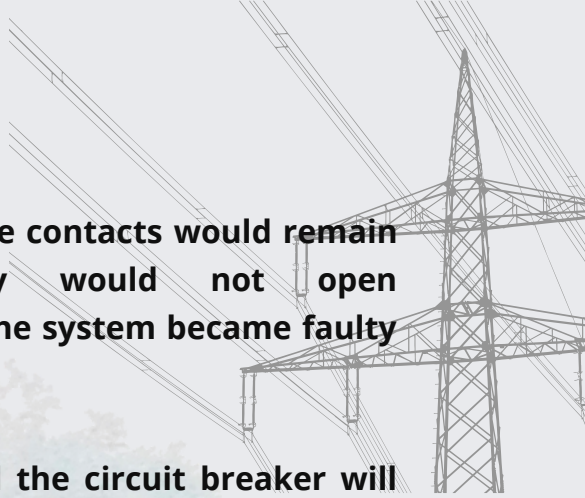

**In a normal state, the contacts would remain closed, and they would not open automatically until the system became faulty or the fault occurred.**

**A shunt coil trip and the circuit breaker will be energized if a fault occurs in any component of the system.**

**The moving contacts will be pulled out by a mechanical system to open the circuit. (moving contact separate from fixed contact).**



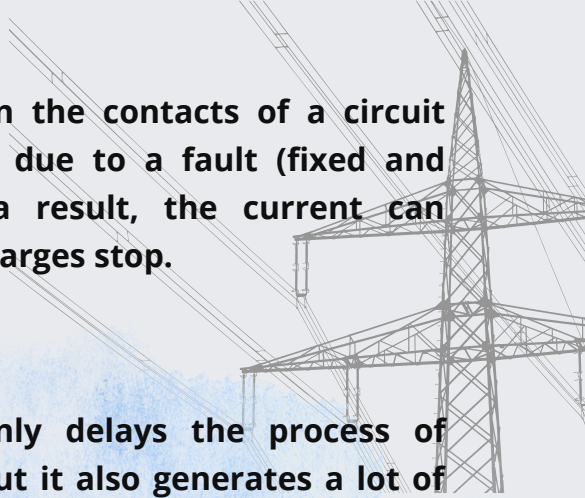

**An arc is formed when the contacts of a circuit breaker are separated due to a fault (fixed and moving contact). As a result, the current can continue until the discharges stop.**

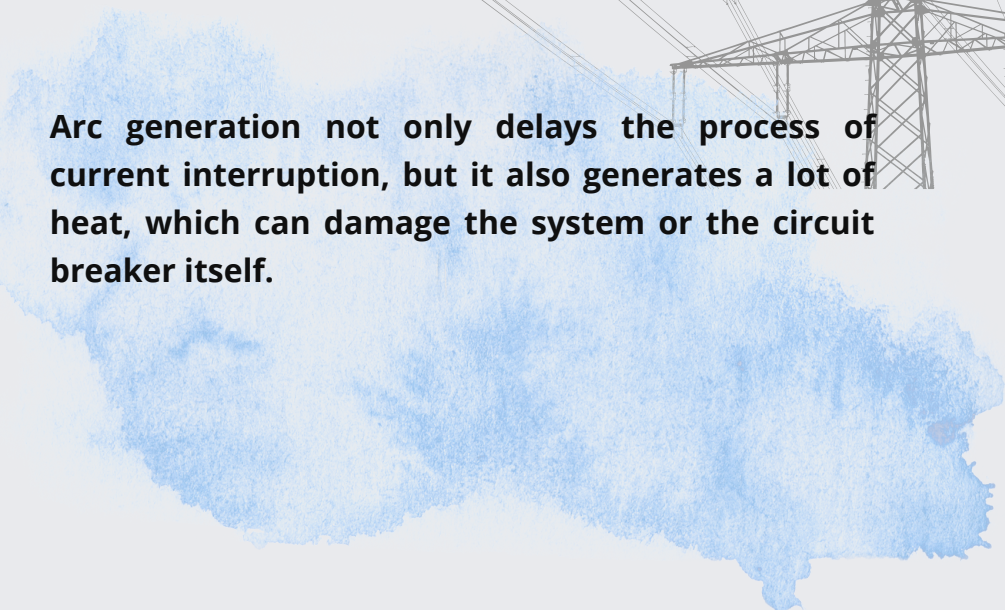

**Arc generation not only delays the process of current interruption, but it also generates a lot of heat, which can damage the system or the circuit breaker itself.**



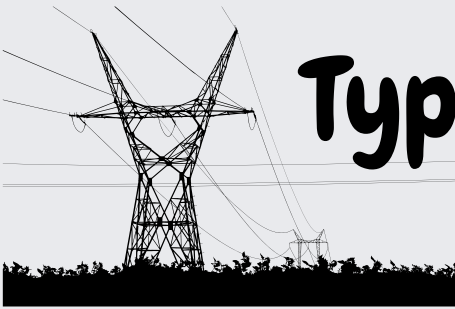

# Types of Circuit Breaker

Circuit breakers are classified into several types based on their structure, tripping type, and voltage ratings.

- Low Voltage Circuit Breaker
- High Voltage Circuit Breaker
- Solid-State Circuit Breaker
- Thermal-Magnetic Circuit Breaker
- Magnetic circuit breakers





# Low Voltage Circuit Breaker

Low voltage circuit breakers are commonly used in domestic, commercial and industrial application . The example of low voltage circuit breaker are:

## MCB (Miniature Circuit Breaker)

The rated current of an MCB (Miniature Circuit Breaker) is no more than 100 A, and the trip characteristics are normally not adjustable. Small power end circuits (socket outlets, lights, control power, etc.) are commonly used.

## MCCB (Molded Case Circuit Breaker)

The rated current of an MCCB (Molded Case Circuit Breaker) is up to 2500 A. In larger ratings, thermal or thermal-magnetic operation, as well as trip current, may be adjustable.





**Figure 13 :Low Voltage Circuit Breaker  
( <https://myelectrical.com/> )**





# High Voltage Circuit Breaker

High Voltage Circuit Breakers are available for both indoor and outdoor use. The most general type of HV Circuit Breaker is based on the medium used for arc extinction. The medium for arc extinction such as oil, air, and Sulphur Hexafluoride (SF<sub>6</sub>).



**Oil Circuit Breaker**



**Air Circuit Breaker**



**Vaacum Circuit Breaker**



**Sulphur Hexafluoride(SF<sub>6</sub>) Circuit Breaker**





**Figure 14 :Vaacum Circuit Breaker**  
( <https://studyelectrical.com/>)







# Protective Relay

A protective relay is a device **that detects a fault and activates the circuit breaker to isolate the faulty component from the rest of the system.**

Relays detect abnormal conditions in an electrical circuit by continuously measuring electrical values that differ between normal and faulty conditions.

After detecting the fault, the relay closes the breaker's trip circuit. As a result, the circuit breaker trips, and the faulty condition is removed.



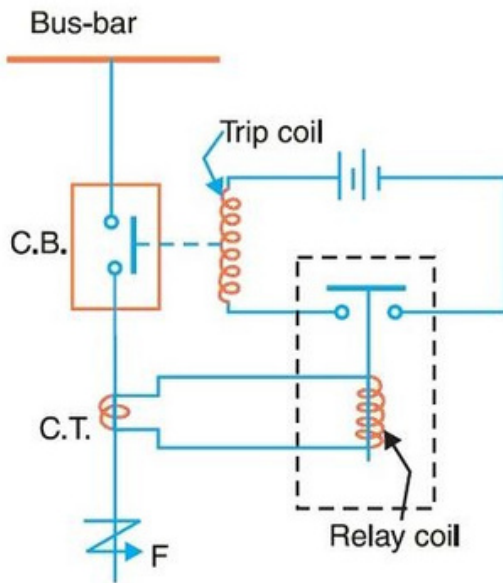

**Figure 15 :Basic Schematic Circuit for Protective Relay**  
 ( <https://studyelectrical.com/>)



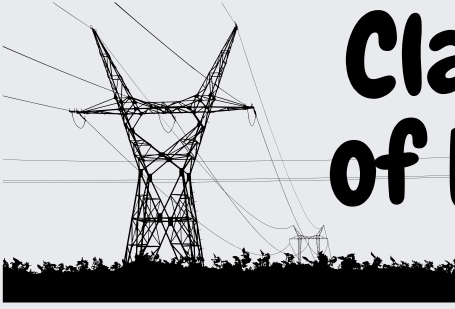

# Classification of Protective Relays

Protective relays can be classified in a variety of ways based on their construction, function, and other factors. The classification of protective relays are based on:

- Technology
- Functions
- Protective schemes



## Classifications of Protective Relays Based on Technology

- Electromagnetic Relays
- Static Relays
- Microprocessor-Based Relays

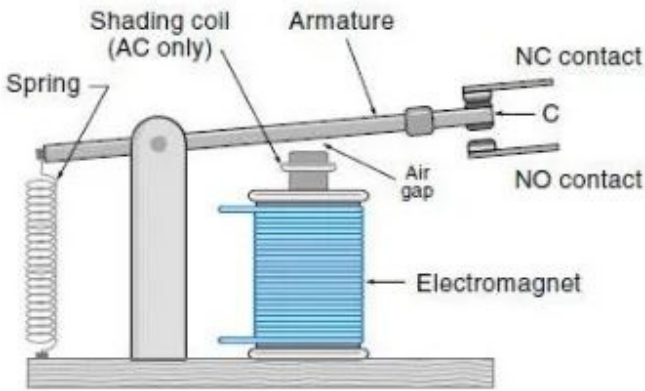

**Figure 16 :Basic Structure of Electromagnetic Relay**  
( <https://www.electrical4u.com/> )



## Classification of Protective Relays Based on Their Function

- Overcurrent relays
- Undervoltage relays
- Impedance relays



Figure 17 :Overcurrent Relay  
(<http://jayasukses.com/>)





## Classification of Protective Relays Based on Protective Schemes

A protective scheme is used to protect equipment or a section of the line. It consists one or more relays of the same or different types.

- Overcurrent Protection
- Distance Protection
- Differential Protection
- Pilot Protection

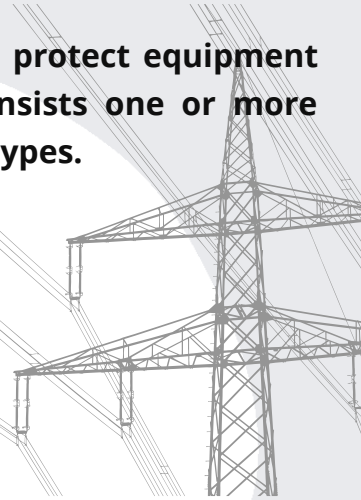

Figure 18 :Differential Protection Relay  
(<https://www.tecequipment.com/> )





# Fuses

A fuse is a short piece of metal that is inserted into a circuit and melts when an excessive current flows through it, thereby breaking the circuit.

Silver, copper, and other materials with low melting points and high conductivity are commonly used to make fuse elements. It is connected in series with the circuit that needs to be protected.

The fuse element is at or near its melting point under normal operating conditions and can carry the normal current without overheating.



When there is a short circuit, the current flowing through the fuse increases, raising the temperature and causing the fuse element to melt, thereby disconnecting the protected circuit.



**Figure 19 :Differential Protection Relay**  
(<https://library.automationdirect.com/> )







# Types of Low Voltage Fuses

## HRC Fuse

- The fuse wire or element in that type of fuse can carry short circuit heavy current for a known time period.
- This fuse is reliable and has an inverse time characteristic, which means that when the fault current is high, the rupture time is short, and when the fault current is low, the rupture time is long.

## Semi-enclosed Rewireable Fuse

- A rewireable fuse is used to interrupt low values of fault current.
- These fuses are made for rated currents up to 500A, but their rating capacity is limited. This fuse is only suitable for domestic and lighting loads.





## Cartridge Fuse

- In a cartridge fuse, the fuse wire is enclosed in a transparent glass tube or bulb, and the entire unit is sealed.
- Because the cartridge fuse cannot be rewired due to its sealing, a new one must be installed if it blows.



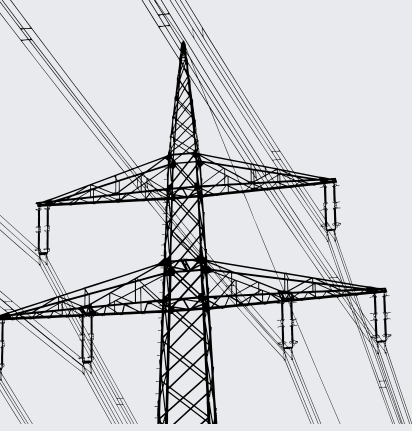

# Batteries

Batteries provide power in the event of a power outage in the system. Batteries provide energy to power circuit breakers, allowing them to trip when a fault occurs.

If the incoming power fails completely, the circuit breakers can still be used to restore the situation using the power of the storage station battery. As a result, the battery has become an important part of the power system.





**Figure 20 :Battery Bank**  
(<https://www.tendersontime.com/>)





# Self-Test Question

1. In an electrical power system, a \_\_\_\_\_ is used to step down the system voltage to a safe level that may be delivered to low-power meters and relays.
2. A circuit breaker main function is to \_\_\_\_\_ the flow of current when a fault occurs.
3. A protective relay is a device that \_\_\_\_\_ and activates the circuit breaker to \_\_\_\_\_ the faulty component from the rest of the system.
4. The \_\_\_\_\_ is at or near its melting point under normal operating conditions and can carry the normal current without overheating.



05

# ***PROTECTIVE ZONES***





# What is Protective Zones?

Protective zones are separate zones that are established around each power system element.

In the event of a fault, protective zones can be separately protected and separated, letting the rest of the system to continue operating as much as possible.

The significance of such a protective zone is that any fault occurring within it will cause relays to trip, causing all circuit breakers within the zone to open.



A power system can be divided into protection zones, which include generators, transformers, groups of generator transformers, motors, busbars, and lines.

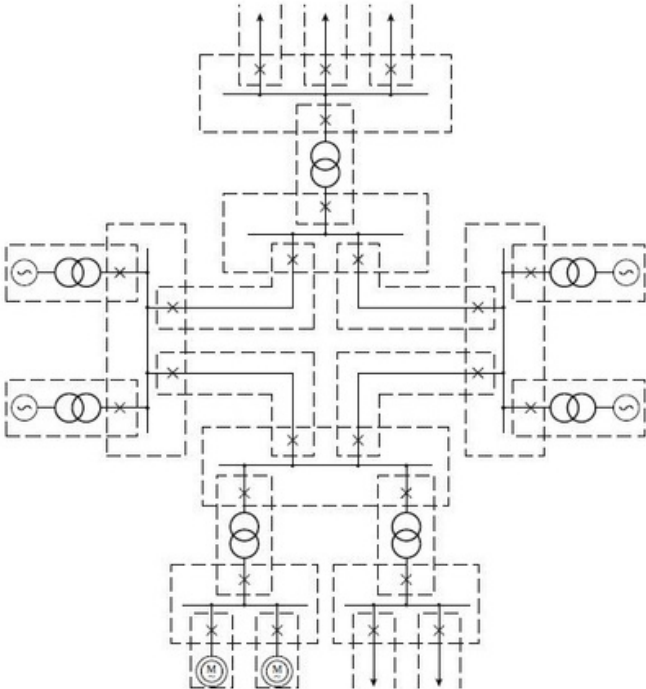

**Figure 21 :Protection Zones  
(Protection of Electricity Distribution Network,  
2nd Edition)**







# Overlapping Zones

The zones overlap at some points, implying that if a fault occurs in these overlap areas, multiple sets of protective relays should be activated.

The overlapping of protection zones is done to ensure that each and every component of the system is completely safe.

The fault in the overlapping zones causes one or more circuit breakers associated with the zones to trip, thereby isolating the system.



If power system does not have overlapping in the protective zone, any equipment failure will not occur in any of the zones, and so no circuit breaker will be tripped. When a fault occurs in an unprotected system, the equipment is damaged, and the supply is disrupted.

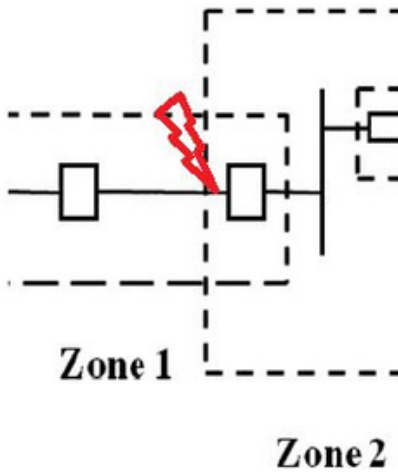

Figure 22 :Overlapping Zones  
( <https://www.electrical4u.com/>)



# Primary and Back-up Protection



To ensure that the relays only activate when a failure occurs, all elements of the power system must be appropriately protected. Unit type protection, only operate for faults that fall within their protection zone.

Non-unit protection can detect faults both inside and outside of a specific zone, usually in adjacent zones, and can be used as a backup to the primary protection as a second line of defence.



## Primary Protection

Primary protection should be initiated when an element detects a failure in the power supply. One or more power system components, such as electrical machines, lines, and busbars, are protected by the protection element. Multiple primary protection devices may be present in a power system component.

## Back-up Protection

Back-up protection is configured to operate when the primary protection fails. To accomplish this, the backup protection relay includes a sensing element that may or may not be similar to the primary protection, as well as a time-delay facility to slow down the relay's operation and give the primary protection time to operate first.





# Self-Test Question

1. Protective zones are \_\_\_\_\_ that are established around each power system element.
2. Protection zones include generators, transformers, \_\_\_\_\_, motors, busbars, and lines.
3. The overlapping of protection zones is done to ensure that each and every component of the system is \_\_\_\_\_.
4. \_\_\_\_\_ is set up to operate when the primary protection fails to operate.
5. \_\_\_\_\_ only operate for faults that fall within their protection zone.





# ***TUTORIAL QUESTION***





# Tutorial Question

1. State FOUR (4) objectives of protection of power system.
2. Explain the difference between symmetrical faults and unsymmetrical fault.
3. Describe FOUR (4) basic components for protection system.
4. Explain the following basic requirements for protection system:
  - i. Reliability
  - ii. Selectivity
  - iii. Sensitivity





# Tutorial Question

5. In general a power system can be divided into SIX (6) protection zones – generators, transformers, group of generators transformer, motors, bus bars and lines. Protective zones is the separate zones which is establish around each system element. Draw the SIX (6) protective zone diagram for a sample power network and explain why the zones needs to overlap at some point (overlapping zones).

6. Sketch a schematic diagram that shows the basic component of protection system.

7. Describe about the protection below:

i. Back-up protection

ii. Unit protection







# REFERENCES

1. J. Lewis Blackburn, T. J. (2006). Protective Relaying Principles and Application, Third Edition. Taylor and Francis Group.

2. Juan M Gers, E. J. (2005). Protection of Electricity distribution Network, 2nd Edition. The Institution of Engineering and Technology, London.

3. V. K. Mehta, R. M. (2008). Principle of Power System. S. CHAND & COMPANY LTD.

4. Retrieved from Electrical 4U:  
<https://www.electrical4u.com/types-of-electrical-protection-relays-or-protective-relays/>

5. Mohamed T. Lazim Alzuhairi, D. M. (2020). Retrieved from Electrical Engineering Portal: <https://electrical-engineering-portal.com/download-center/books-and-guides/relays/power-system-protection>



## WRITER BIOGRAPHY

**Noranizah Bt Solihin** has been a lecturer more than 12 years and now working at Department in Electrical Engineering, Politeknik Merlimau. She holds a Bachelor of Engineering (Hons) Electrical from Universiti Teknologi Mara (UiTM), Diploma in Electrical Engineering (Power) from Universiti Teknologi Mara (UiTM) and Diploma in Education from Universiti Tun Hussein Onn Malaysia.

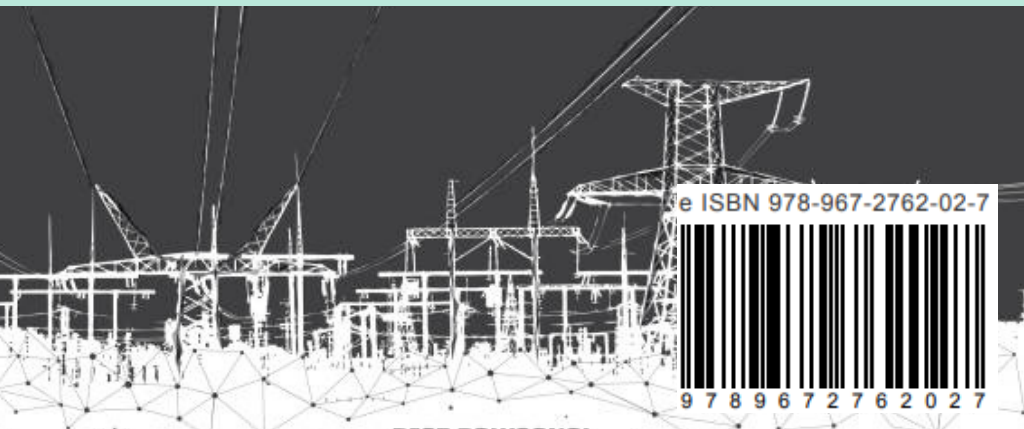

e ISBN 978-967-2762-02-7



9 78 967 2762 027